

SUBSURFACE INSTRUMENTS, INC. DIGITAL NOISE REDUCTION WATER LEAK DETECTOR

LD-18

OPERATION MANUAL



Table of Contents

Foreword	3
Use of this detector	4
Precautions	5
Warranty period	7

< Hardware Volume >

1. Product composition	8
2. Main unit	9
2-1 Operation and Display area	9
2-2 Connector area	10
2-3 Main body battery unit	10
2-4 Pick-up sensor with hand switch	11
3. Before use of the detector	12
3-1 Check of components	12
3-2 Check of battery capacity (Replacement of batteries, if necessary)	12
3-3 Check of date and hour (setup)	14
3-4 Check of operation of the detector	14
4. Method for setup	15
5. Description of functions	16
5-1 Screen operation flow	16
5-2 How to save minimum level value	18
5-3 Graph screen	20
5-4 How to delete minimum level value	21
6. Method for water leak detection	22
7. Method for use in correspondence to situation of the field	25
8. Storage of detector	26
9. Troubleshooting	27
10. Description of terms	28
11. Equipment specification	30
11-1 Specification for main unit	30
11-2 Specification for pick-up	30
11-3 Specification for headphones	30
11-4 Specification for USB connecting cable	31

< Software Volume >

1. Introduction	32
1-1 What is “WLDwin software”?	32
1-2 Operating environment (recommended)	32
1-3 Before use	32
2. Installation and start-up of WLDwin software	33
2-1 Installation	33
2-2 Start-up of WLDwin software	35
3. Driver installation	36
3-1 Installation	36
3-2 Check of communication with detector	39
3-3 Installation: If the hardware search wizard fails to start automatically	40
4. Description of functions of WLDwin software	41
4-1 Main screen (that appears at the time of start-up)	41
4-2 Data read	44
4-3 Graph display	45
4-4 Data save	47
4-5 Text data create	47
4-6 Graph copy	47
4-7 New document	47
4-8 Folder setup	47
4-9 Print	48
4-10 Clearing of saved data in detector	48
4-11 Setup of detector date / hour	48
4-12 Termination processing	48
4-13 Help	49
5. WLDwin error message	50
Parts list and illustrations	52
(1) Main unit	52
(2) Hand-switch set with pick-up sensor	54

Foreword

Thank you very much for your recent selection of our water leak detector LD-18. This Operation Manual pertains to operation and handling of water leak detector LD-18.

This manual mainly describes how to use this detector and how to use its software. Make sure to read this manual and become fully acquainted with operation and handling of this detector before its use. If there is any matter that is not clear enough to you regarding operation and handling of this detector, please contact our office.

You are kindly requested to keep this manual in a place of easy access for permitting reference to it whenever it is needed. If this manual is lost, please contact our nearest distributor.

Use of this detector

This detector has been designed to identify the point of water leak by detecting the water leaking sound, which is produced out of a waterworks pipe buried under the ground, from the ground surface.

<Overview of detector>

With each of low frequency zone and high frequency zone of output frequency band set at four stages, noise reduction water leak detector LD-18 is capable of flexibly dealing with the difference in the water leak sound caused by the difference in the pipe type and with the noise produced on the field, by selecting a combination that can be easily identified out of 19 different combinations. Furthermore, it permits visual judgment of the noise level by level bar display. In addition, with noise eliminating function, it is possible to eliminate accidental noise such as vehicle passing sound and bowwow. This water leak detector LD-18 is capable of discriminating water leak sound to a level that is higher than that of conventional detector.

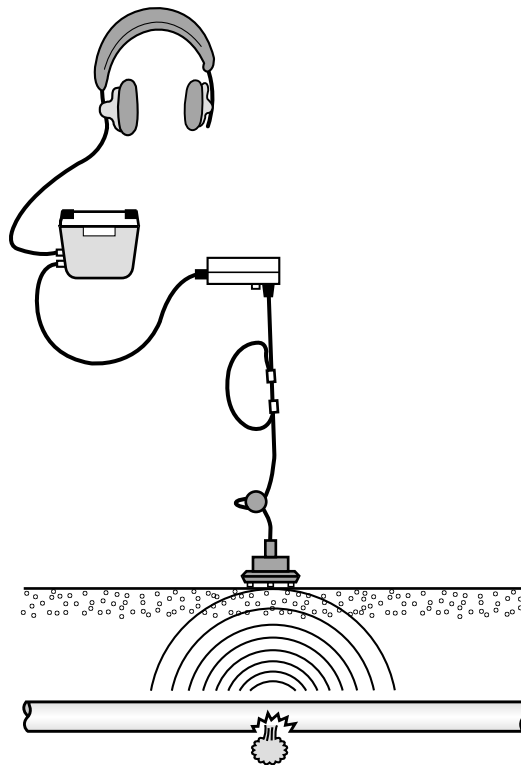



Precautions

Carefully read and fully understand safety precautions described below before use of the detector.

- Observe instructions and procedures described in the manual for operation and handling of the detector.
- Make sure to observe the precautions described in this manual and marked on the detector.

<Symbols used>

Safety precautions are shown under headings indicated below.

 WARNING	This heading is used for showing latent risk that may trigger death or serious injury.
 CAUTION	This heading is used for showing latent risk that may trigger personal injury of minor or medium extent.
CAUTION	This heading is used for showing latent risk that may trigger serious damage to the equipment and/or to surrounding articles.

 WARNING	
	<ul style="list-style-type: none">● When a headphone is used for hearing water leak sound during use of this detector, it is hard to hear the ambient sound. Be cautious.● Do not attempt to replace batteries, and do attempt to operate this detector you're your hands are wet.● Pay attention to the polarity of batteries at the time of battery replacement. (Liquid leak, heat-up, breakage or the like may arise otherwise.)● Do not throw any battery into an open flame. (Burst, fire and personal injury may result otherwise.)● Do not attempt to dismantle any battery. (Burst, fire and personal injury may result otherwise.)

Precautions



CAUTION

- Positively fit the battery compartment cover. If its fitting is incomplete, it may drop off while the detector is used, permitting drop-off of batteries, and personal injury may result.
- Do not swing the main body or pick-up.
- Do not shelve this detector in a place of high temperature. (Failure may result.)
- Do not use this detector for any application other than water leak detection.
- The main body and hand-switch part are not of waterproof structure.
Do not immerse them in the water, and avoid their use in the rain. (Failure may result.)
- Do not drop this detector, and do not apply strong impact to it. (Failure may result.)
- Do not dismantle this detector. (Failure may result.)
- Remove batteries, if it is scheduled that this detector will not be used for a long time.
- Do not unnecessarily pull the pickup cable.
(Use of the pick-up may be disabled due to occurrence of wire disconnection in the cable.)
- Keep watching the surrounding situation during the work.
- Observe regulations of the local municipality when it is wanted to dispose this detector.

Warranty period

The warranty period of this detector is one year (12months) counted from the date of its purchase.

The “Warranty certificate” assures our best service to the customer.

Enter the customer’s name, address and date of purchase in the “Warranty certificate” and lay it up in lavender.

Kindly give the “Warranty certificate (for file)” to our sales representative or mail it to our office.

Should any functional trouble arise to this detector during the warranty period, we will carry out repair at no cost to the customer. Presentation of the “Warranty certificate” is required in such a case.

Please kindly understand it in advance that our service will be provided for value, unless the “Warranty certificate” is presented.

If any trouble arises after the warranty period or if any failure occurs due to a reason for which the customer is responsible, our service will be provided for value.







Please contact the nearest distributor if you have any questions regarding this detector.

Hardware Volume





1. Product composition

[Hardware]

Standard components

<ul style="list-style-type: none"> • Main unit : 1ea. 	<ul style="list-style-type: none"> • Pick-up sensor with hand-switch set : 1ea. 	<ul style="list-style-type: none"> • Headphones (ST-3) : 1ea. 
<ul style="list-style-type: none"> • WLDwin software (CD-ROM) : 1ea. 	<ul style="list-style-type: none"> • Shoulder strap : 1ea. 	<ul style="list-style-type: none"> • Battery (U2) : 4ea. 
<ul style="list-style-type: none"> • Aluminum carrying case : 1ea. 	<ul style="list-style-type: none"> • USB connecting cable : 1ea. 	<ul style="list-style-type: none"> • Operation manual : 1ea. 

Optional accessories

<ul style="list-style-type: none"> • Pick-up sensor with 3m cable for valve / fitting surveying 	<ul style="list-style-type: none"> • Aviation grade stereo headphones 
<ul style="list-style-type: none"> • Hard carrying case (ABS resin) 	<ul style="list-style-type: none"> • 3 contact bar and disc plate 

2. Main unit

[Hardware]

2-1 Operation and Display area

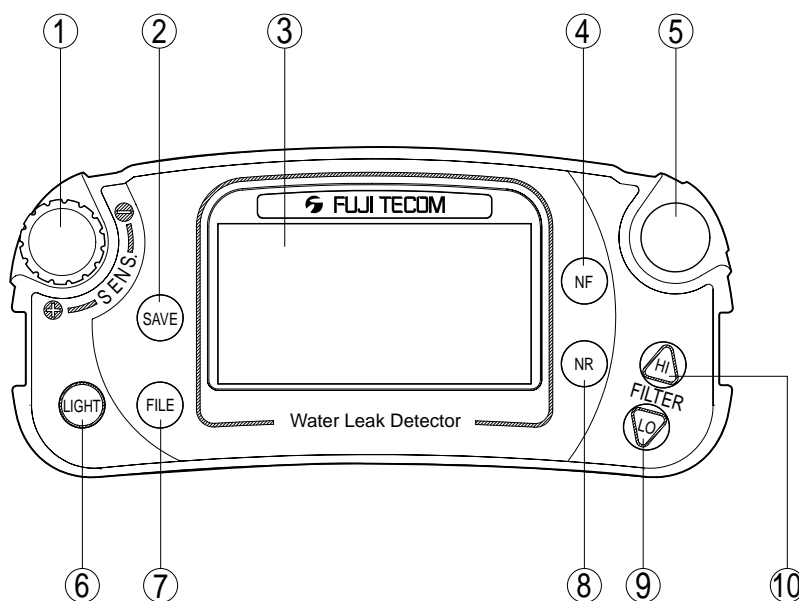

- ① **SENS. (sensitivity)** : Sensitivity control dial
Use this dial for sensitivity setup out of the range of 00 to 40.
- ② **SAVE** : Use this switch for saving minimum level value.
- ③ **Liquid crystal display** : Displays a level bar, minimum level value, battery capacity, filter setup and others.
- ④ **NF (notch filter)** : Use this switch when it is wanted to cut the noise of commercial AC power supply.
- ⑤ **Alternate ON / OFF switch**:
Use this switch in case optional pick-up sensor dedicated to valve / tap sound is used.
(Do not use this switch for ordinary road surface sound hearing work.)
- ⑥ **LIGHT** : Backlight ON / OFF switch
- ⑦ **FILE** : This switch permits check of saved data and waveform.
- ⑧ **NR (noise reduction)** : Use this switch when it is wanted to reduce accidental sound and noise.
- ⑨ **LO** : Use this switch for setting the filter's low cut range. This switch can be also used for DOWN of a file screen or a graph display screen.
- ⑩ **HI** : Use this switch for setting the filter's high cut range. This switch can be also used for UP of a file screen or a graph display screen.

2-2 Connector area

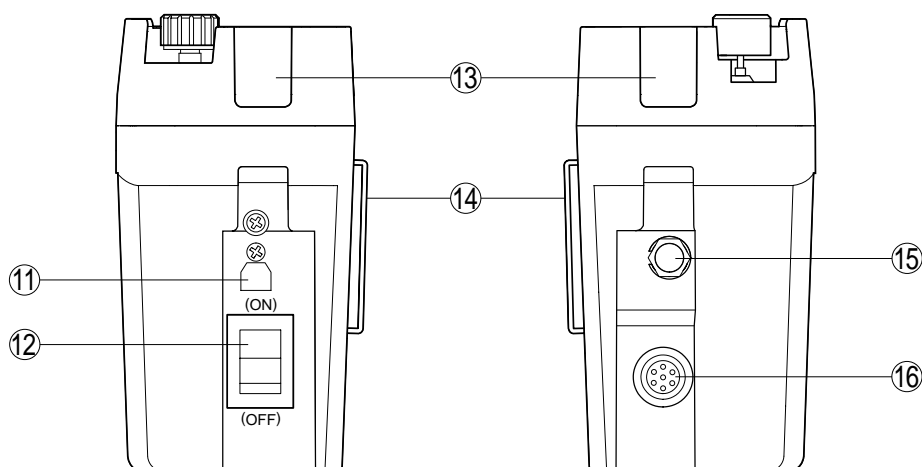

① USB cable connector

Use this connector for connection with a PC.

② Power switch of main unit

Switch for power ON / OFF.

③ Shoulder strap fitting

Good for fitting the provided shoulder strap.

④ Waist belt fitting

Good for fitting the belt at the time of mounting of the main body to the lower back.

⑤ Headphone jack

Use this connector for connection of a headphone.

⑥ Connector for pick-up sensor with hand switch

Use this connector for connection of the pick-up sensor with hand switch.

2-3 Main body battery unit

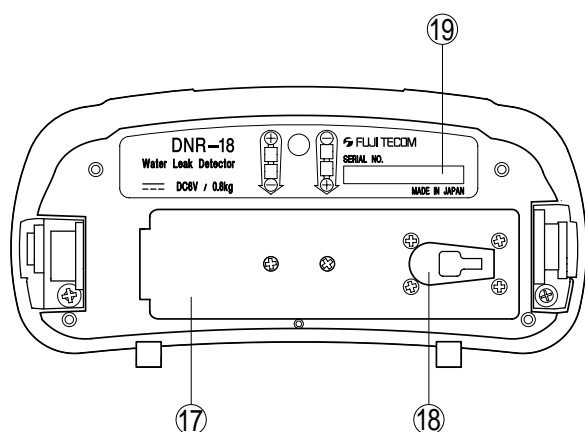

⑦ Battery compartment

Place two batteries (four alkali c-size batteries) in this compartment.

⑧ Cover lock

Use this lock for opening and closing the battery compartment cover.

⑨ Production seal

The battery fitting direction and serial number of this detector are indicated on this seal.

2-4 Pick-up sensor with hand switch

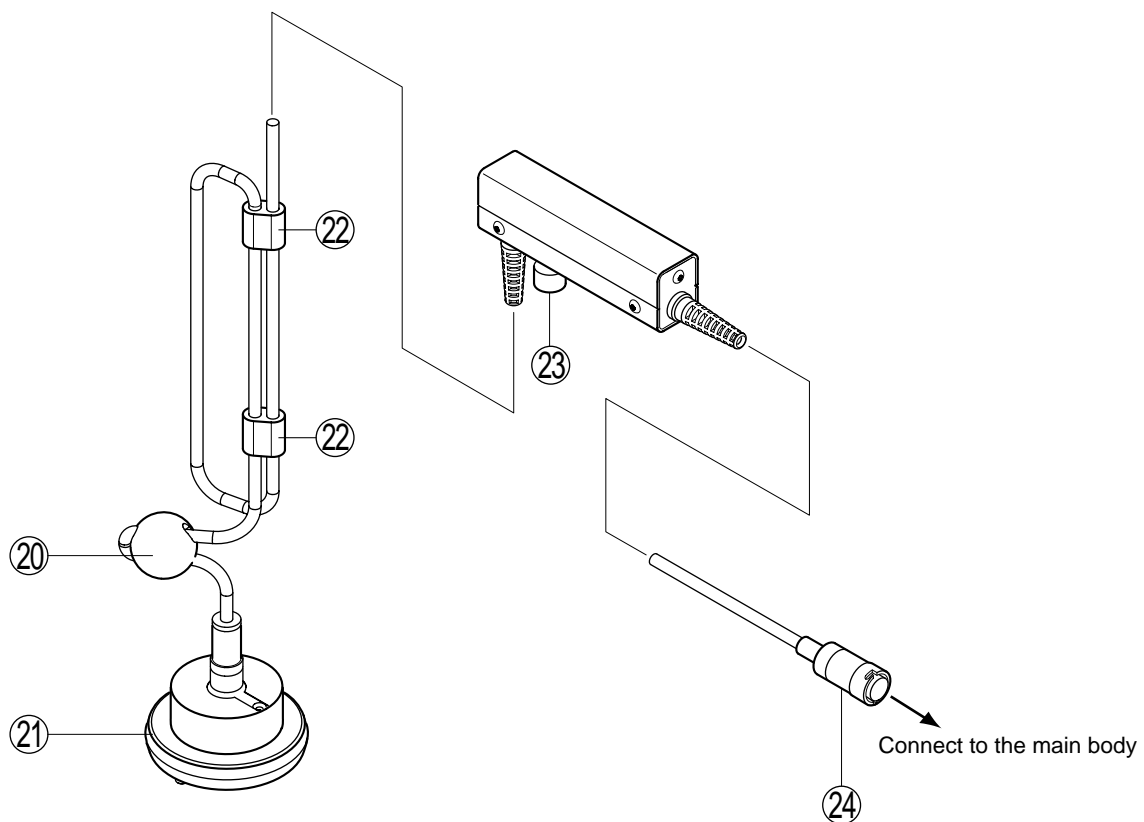

⑳ Rubber ball for reducing the noises

Reduces noises such as wind noise and cable friction noise.

㉑ Pick-up sensor

The sensor picks up the water leak sound.

㉒ Cable length adjuster

Use this parts for adjusting the cable length.

㉓ Hand switch

Sound is picked up when the button is pushed, and the sound is gone when the button is released.

㉔ Connector

Use this connector for connection with the detector main body.

3. Before use of the detector

[Hardware]

- Make sure to make the following four checks before use of this detector, to permit this detector to fully exhibit its performance.
 1. Check of components
 2. Check of battery capacity (Replacement of batteries, if necessary)
 3. Check of date and hour (setup)
 4. Check of operation of the detector

You are kindly requested to have the detector totally inspected by our maintenance department periodically (once every 12months), for assuring safe use of this detector.

3-1 Check of components

Assure that all the components are provided, with reference made to page8 of this manual.

Please contact us, if any component is missing.

3-2 Check of battery capacity (Replacement of batteries, if necessary)

<Check of battery capacity>

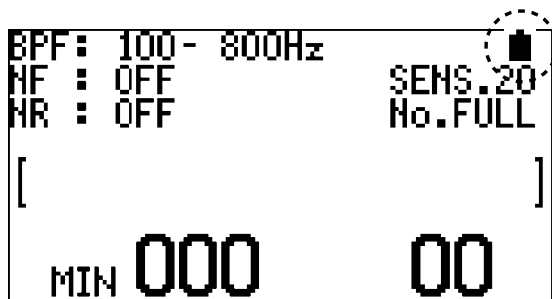

- Make sure to check if the battery capacity is sufficient before use.

To check the battery capacity, turn ON the power for the main body.

When the capacity of battery went down, it is indicated by the “” mark.

If the mark is flickering (), replace batteries immediately.

(*Make sure to replace batteries in the state where the power for the main body is turned OFF.)
- It is recommended that spare batteries are always provided for water leak detection work, so that batteries can be replaced when the battery capacity is gone.

<Opening/closing of battery compartment cover and replacement of batteries>

- First of all, assure that the power for the main body is OFF.
- Lift the cover lock tab, and remove the battery compartment cover.
- Replace batteries in accordance with the indication.
- Close the battery compartment cover, and positively lock the cover lock.

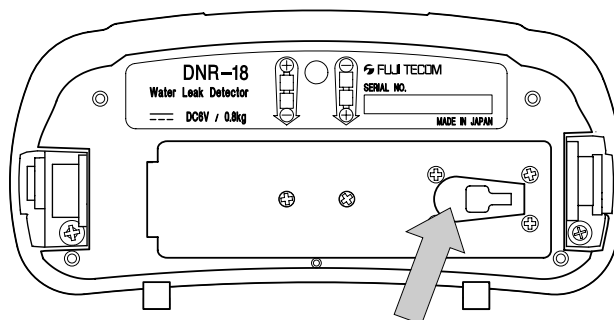

Cover lock: The battery compartment cover opens when this tab is lifted.

**CAUTION**

- Use four alkali C-size batteries (LR14) available on the market.
- If batteries other than what we specify are used, a difference may arise in the continuous use time due to a difference in the battery capacity or depending on working conditions.

**WARNING**

- If batteries other than what we specify are used, our warranty will not cover any failure resulting from them.
- Pay attention to the direction of batteries at the occasion of their replacement. (Burst, fire and personal injury may result.)
- Do not use batteries of different kinds as mixed. (Burst and liquid leakage may result.)
- Do not use unused batteries with used batteries as mixed.
- Dispose of used batteries in accordance with instructions given by the local municipality.

3-3 Check of date and hour (setup)

Setup of date and hour can be implemented using the main body and WLDwin software.

3-3-1 Case of setup using a PC

*Adjust the date and hour of the PC in advance.



- Connect the main body with a PC using a USB connecting cable.
- Turn ON the power for the main body.

See “4-11 Setup of date and hour of detector” of Software Volume (page48) for the operation thereafter.

3-3-2 Case of setup from main body

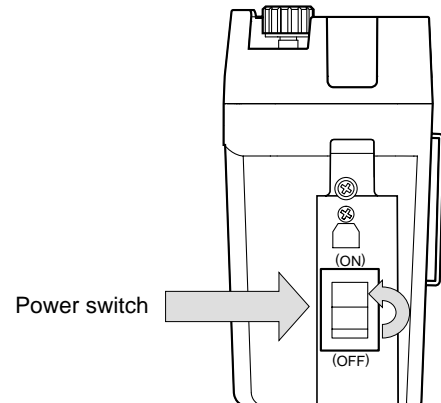
- (1) Turn ON the power for the main body while the  switch is kept pressed.
- (2) The date and hour adjust screen appears.



- (3) Change the date and hour by pressing  and  switches.

*The “minute” value changes when a switch is touched, and the “hour” value changes when a switch is kept pressed for a certain length of time.

Day / date / year can also be changed by pressing a switch for a longer length of time.

- (4) The changed date and hour are saved and the main body starts up when the  switch is pressed.

*To discontinue change to date and hour in the midstream, turn OFF the power without pressing the  switch and then turn ON the power again.

3-4 Check of operation of the detector

Connect the sensor and headphone to the main body, and make the following checks.

(*See “4. Method for setup” (page15).)

- (1) Turn ON the power, and check if the start-up screen appears and the level display screen then appears.
- (2) Press the hand switch and check if sound is produced out of the headphone.
- (3) Check if the bar indicator in the level display screen is in motion.

If any abnormality was observed during any of these checks, see “9. Troubleshooting” (page27).

If the problem is not yet solved, please contact our nearest distributor.



4. Method for setup

[Hardware]

- (1) Take the main body, pick-up sensor with hand switch and headphone out of the case. Correct deformation and kinking of the pick-up cable.
- (2) Put the shoulder strap through the main body.
Or, put a belt through the waist belt fitting.



Using the detector
as mounted on waist



Using a shoulder strap

- (3) Connect the pick-up sensor with hand switch to the main body.
- (4) Adjust the length of the pick-up cable to an appropriate level.

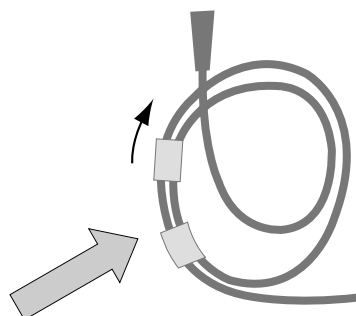

- (5) Connect the headphone to the main body.

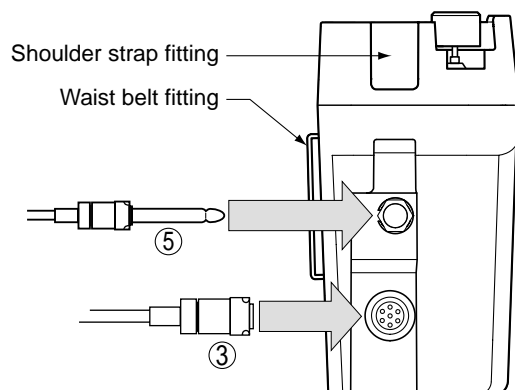

Setup has been completed.

5. Description of functions

[Hardware]

5-1 Screen operation flow

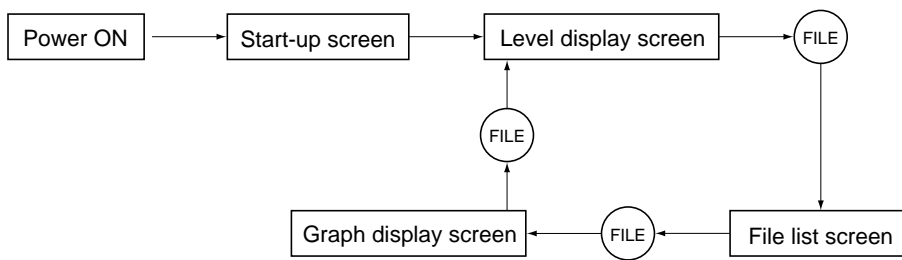

Note : It returns to “File list screen” when (NR) switch is pushed in “Graph display screen”.

5-1-1 Start-up screen



This screen appears when the power for the main body is ON, and then transition to the level display screen occurs immediately.

5-1-2 Level display screen

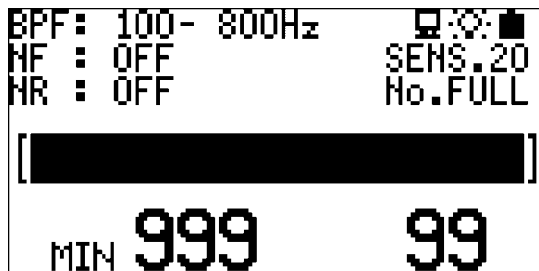

Level bar, SENS, setup of filters, minimum level value and others are displayed for permitting water leak detection work.

- BPF (band pass filter) : Displays filter setup.
- NF (notch filter) : Displays filter setup. (50Hz, 60Hz, OFF)
- NR (noise reduction) : Displays NR setup. (Lv.1, Lv.2, Lv.3, OFF)
- SENS (sensitivity) : Displays sensitivity adjust value. (00 to 40)
- MIN : Displays minimum level value. (000 to 999)
- Bar numerical value : Displays numerical value of the level bar. (00 to 90)
- : Lit while the main body is connected to a PC.
- : Lit while the backlight is in use.
- : Displays the battery capacity. (Display is made in three different levels. Replace batteries if this mark begins to flicker.)
- No.FULL : Appears when the number of saved files reached the full level (250 files).

*** Caution**

- “Level bar display” and “Level value of level bar display” operate as interlocked with the SENS value.
- The minimum level value is of no relation to the SENS value. It automatically compensates the amplifier gain in the main body and displays it.

5-1-3 File list screen

FILE LIST			
No.	MIN		
001	:042	07/07/23	11:09
002	:051	07/07/23	11:09
003	:049	07/07/23	11:09
004	:051	07/07/23	11:09
005	:048	07/07/23	11:09
<input type="checkbox"/> ON-OFF(SAVE) / DEL(NF)			

The file list screen appears when the **(FILE)** switch is pressed in the level display screen.

This screen permits check and deletion of the saved minimum level value.

Furthermore, a flag can be marked for demarcation of the field.

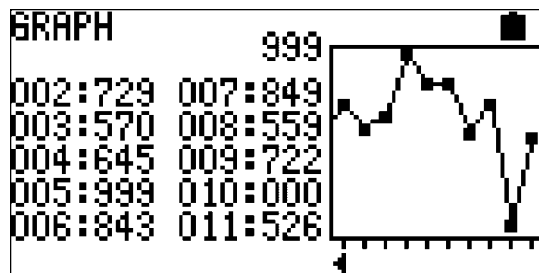
5-1-4 Graph display screen

The graph display screen appears when the **(FILE)** switch is pressed in the file list screen.

The files beginning with the file next to the file marked with flag and ending with the latest file or with the flag are displayed in a graph format.

<Setup statuses at the time of start-up>

The main body starts up in the following statuses when its power is ON.

BPF : 100to800Hz

NF : OFF

NR : OFF

SENS.: 20

*The setup changed at the time of use is not stored. Return to the setup at the time of start-up occurs when the power is turned OFF and is then ON again.

5-2 How to save minimum level value

It is possible to save file No., minimum level value, date / hour, flag and others.

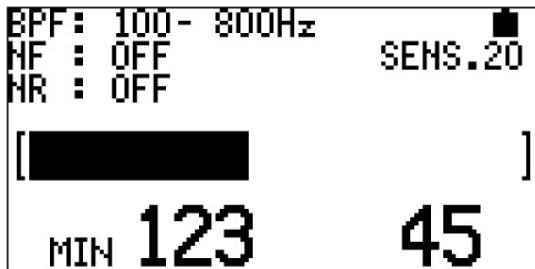

The file list screen appears when the (FILE) switch is pressed in the level display screen.

This screen permits check and deletion of the saved minimum level value.

Furthermore, a flag can be marked for demarcation of the field.

In the level display screen;



Search for minimum level value begins when the (SAVE) switch is pressed in the state where the hand switch (or sound switch) is kept pressed (sound hearing state).

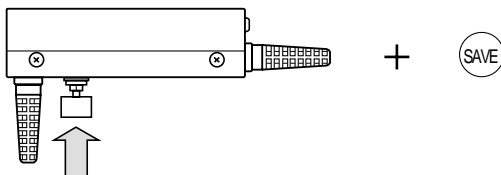

The file save destination file No. is lit in the mean time.

The minimum level value being searched for is saved when the local switch (or sound switch) is released.

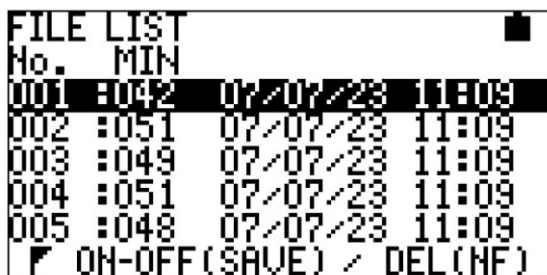
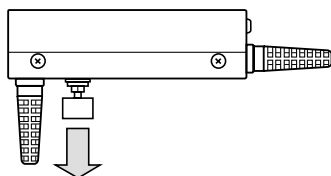

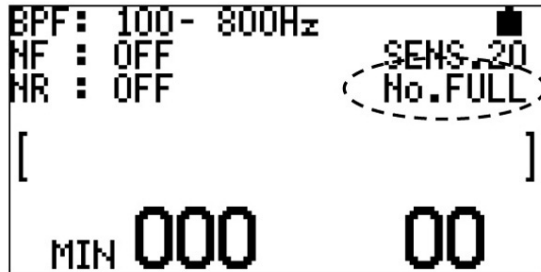

Up to the largest file No. can be saved in the same manner. (Up to 250 data)

“FULL” lights up and stays lit in the screen when the number of data reaches 250.



When the  switch is pressed, the save destination returns to file No.1, and overwrite to file No.1 occurs.

* Caution



- Return to file No.1 will not occur unless FULL is cancelled by pressing the  switch in the level display screen. (Data save will be disabled thereafter.)
- Data save is always implemented to the latest file.
-  flag can be added and deleted to / from the save data at the cursor position by pressing the  switch in the file list screen.



Point

<How to use a flag>

When minimum value of water leak is collected while performing the work, it becomes hard to identify which data is from which field.

Therefore, add a  flag each time when data save terminates in a specific field.

 flag can be added and deleted to / from the save data at the cursor position by pressing the  switch in the file list screen.

In other words, the portion between a  flag and the next  flag represents data acquired from a specific field.





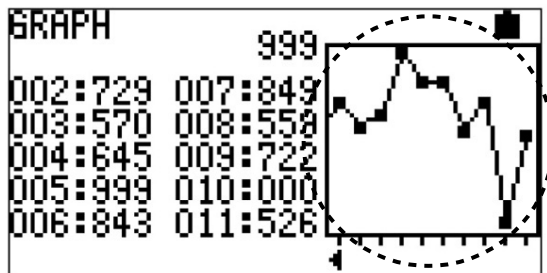

5-3 Graph screen

- The graph screen displays saved data in a graph format.



- The data displayed in a list format on the left-hand side of the screen is displayed in a graph format on the right-hand side of the screen.

* Caution

- In case flags were set in the file list screen, data of the section beginning with data next to data with  flag to the latest data or to the next data with  flag is displayed in a graph format.
- Up to ten (10) data is displayed in a screen format. When ten data is exceeded,   cursor appears at the bottom of the graph on the right-hand side of the screen, and the graph can be scrolled using  and  switches.

 Rightward scroll occurs when the switch is pressed.

 Leftward scroll occurs when the switch is pressed.

5-4 How to delete minimum level value

It is possible to delete the minimum level value saved in the main body, either using the main body or using WLDwin software.

5-4-1 How to delete using main body

(1) Move the cursor to the file to be deleted in the file list screen.



(2) Press the (NF) switch. A message that asks whether to delete the saved file at the cursor position or not appears at the bottom of the screen.

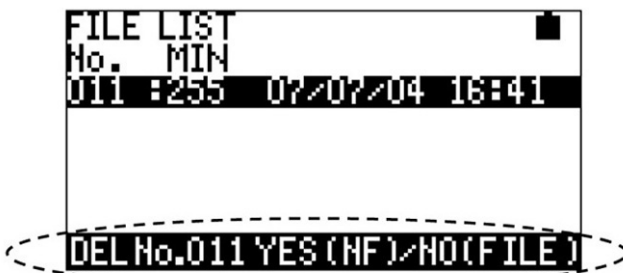

(3) Press the (NF) switch again. The saved file at the cursor position is deleted.

(4) To cancel deletion, press a switch other than (FILE) switch and (NF) switch. Return to the selection stage occurs.

* Caution

- Once saved data is deleted, it cannot be resumed.
- Deletion of data in a batch can be implemented from WLDwin software only.

5-4-2 How to delete using WLDwin software

See “4-10 Clearing of detector saved data” (page48) for details.

6. Method for water leak detection

[Hardware]

When water leak occurs from a water pipe buried under the ground, the water jets out with force because of the water pressure in the pipe. Such water leak accompanies compound sound involving four elements, i.e., (1) water flow sound, (2) impact sound, (3) to-pipe friction sound and (4) pipe vibration sound. This compound sound is called water leak sound in general.

The acoustic quality of the water leak sound that passes on to the ground varies by conditions such as situation of occurrence of water leak, soil quality, pipe type and depth. In other words, the acoustic quality varies because four elements of compound sound are combined with varied conditions, and there is no case where the frequency distribution shows a constant value.

To locate a point of water leak, this water leak sound is pinned down on the ground through a water leak detector, and total judgment is made by man's sound detecting sensation as combined with situation of the field.

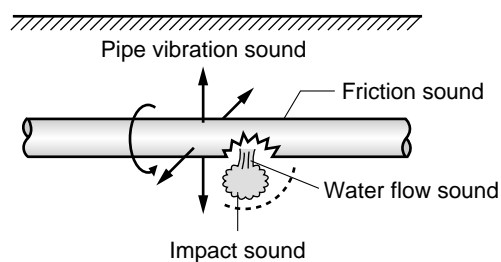

Search for water leak sound while moving the pick-up on the ground along the route of the buried pipe. Carefully determine the point at which the level bar display becomes the maximum, and mark a <maximum point>.

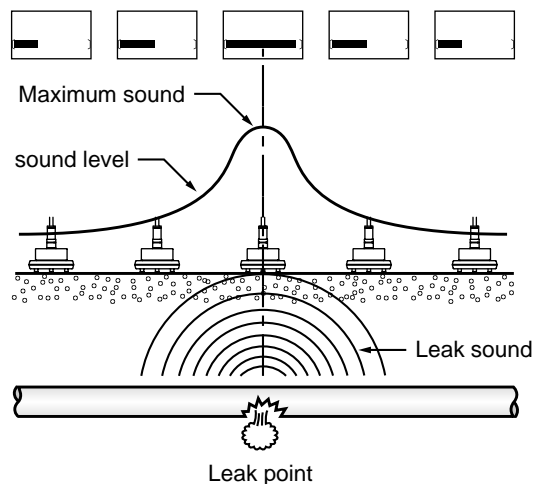

There is a case that the point of the maximum level which is indicated is not right above the point of water leak, depending on conditions in the ground and road surface.

<Conditions that affect water leak detection>

1. Scale of water leak (size of water leak hole in the pipe)
2. Water pressure
3. Soil quality
4. Pipe material grade
5. Pavement type
6. Hydrous soil conditions
7. Sound of consumption water at the house
8. Wastewater inflow sound and dropping sound
9. Sound of air-conditioners
10. Automotive vehicles traveling sound (friction sound)
11. Wind noise
12. Sound from transformers and automatic vending machines
13. Sounds from electricity, telephone cables, motors and pumps
14. Water leakage in a pool condition

(*There are cases where water leak detector is hard depending on conditions stated above.)

**WARNING**

- When a headphone is used for hearing water leak sound during use of this detector, it is hard to hear the ambient sound. Be cautious.

**CAUTION**

- Be careful not to cause damage to your ears at the time of sound hearing with a headphone.

<NR system>

This function permits reduction of transient undesired noise that lacks continuity. High effect is obtained when the set level is elevated. There is a certain time-lag (silent time) in the NR mode before sound is heard through the headphone since the sound hearing switch was pressed.

Lv.1 : 0.2second

Lv.2 : 1.0second

Lv.3 : 3.0second

*** Precautions for use of NR system**

Positively place the pick-up sensor on the ground before pressing the sound hearing switch. If sound hearing is performed in the state where the pick-up sensor is floating, accurate result cannot be obtained in either sound volume or minimum level value.

<SENS switching>

Switching out of the range of 00~40 is permitted. The sensitivity of this detector changes in correspondence to the set numerical value. The magnitude of the sound heard out of the headphone also changes accordingly. The MIN value, however, is not linked to switching of SENS.

<Forced motion OFF>

When the battery voltage becomes less than a certain reference voltage, the motion of this detector is forcibly shutdown for protection of batteries against over-discharge. The screen on the liquid crystal display disappears in this case. Replace batteries with new ones.

<Main unit's alternate ON / OFF switch>

Use this switch in case optional pick-up sensor dedicated to valve/tap sound is used. This switch is push lock type, so it doesn't need to hold down the push button. When the lock switch is ON, the sound is suddenly outputted after main unit start up. Be careful at the time of the sensor use of main unit's switch.

7. Method for use in correspondence to situation of the field

[Hardware]

<Filter selection>

- (1) In a place where undesirable noise such as electric pole transformer sound, commercial frequency sound from automatic vending machines, passing sounds from pedestrians' and automotive vehicles and barking dog is excessive, it is possible to more positively pin down the target sound when a combination of BPF+NF+NR processing is applied.
- (2) In a place where undesirable noise such as passing sounds from pedestrians' and automotive vehicles and barking dog is excessive, it is possible to more positively pin down the target sound when a combination of BPF+NR processing is applied.
- (3) In case the level of undesirable noise is low in suburbs or the like, it is possible to pin down the target sound with BPF alone.

Each pipe generates its own leak sound within a certain range of frequency according to the material of pipe. The following examples would be convenient to know the filtered width.

Pipes	100Hz	200Hz	400Hz	600Hz	800Hz	1200Hz
Distribution Pipe CIP		⊙-----	-----	-----	-----⊙	
Distribution Pipe VP	⊙-----	-----	-----	-----⊙		
Service Pipe VP		⊙-----	-----	-----⊙		
Service Pipe GP			⊙-----	-----	-----	-----⊙

<Minimum level value>

As you get closer to the leak, the sound gets louder. Minimum level value decides which two of these locations are the loudest. Minimum level value is corrected for the changes in SENS, However, when you compare it with the other site, we recommend to use the same SENS in good comparison.

8. Storage of detector

[Hardware]

Store this detector as instructed below if it is scheduled that this detector will not be used for a long time.

- (1) Assure that all the components including operation manual are complete.
- (2) Remove batteries.

If batteries are kept in the battery compartment for a long time, damage to equipment may occur due to liquid leakage.

*For storage of batteries for a long time, insulate battery terminals using tape or the like so that no short-circuit will occur.

- (3) Do not store the detector in a wet place.

(Storage after use of detector)

- (1) Carefully remove mud and dirt from the pick-up, before placing it in the case. (Trouble may result otherwise.)
- (2) If the detector was wetted with rainwater, fully remove the rainwater from the detector before storage.
- (3) Fit a rubber cap to each one of all the terminals.
- (4) Do not place any article other than this detector in the case.

Damage and failure may result otherwise.

- (5) Remove batteries from the battery compartment.

9. Troubleshooting

[Hardware]

Read instructions in this section when any malfunction arises to this detector. If the detector is still disabled after taking measures described below or if the trouble phenomenon is other than what are described below, please contact our nearest distributor.

<p>(1) If the power for the main body cannot be turned ON:</p>	<ul style="list-style-type: none"> • Check if batteries are located in the battery compartment. • Try to replace batteries with new ones. • Check if batteries are located in correct polarity. • Wipe battery terminals using soft cloth or the like, and once again if the power is ON. *There are cases where the contact between battery terminals was worsened and sufficient power is not supplied to the main body. • There are cases where start-up will not occur if the power is ON immediately after power OFF. In such a case, turn OFF the power once and then turn ON the power again.
<p>(2) Saved data and / or date / hour is erroneous when the power is ON.</p>	<ul style="list-style-type: none"> • It indicates the time of replacement of the built-in battery. Please contact our nearest distributor.
<p>(3) The screen on the liquid crystal display has faded when the detector was moved to a cold area.</p>	<ul style="list-style-type: none"> • Turn OFF the power and then turn ON the power again. The liquid crystal concentration is adjusted automatically at the time of start-up.
<p>(4) Although the detector is connected to a PC, communication with the PC is disabled.</p>	<ul style="list-style-type: none"> • Check if the USB cable is connected to both of the main body and PC. • The  mark appears in the level display screen when connection with a PC is confirmed. (See “5-1-2 Level display screen” (page16).) • Check the battery capacity. (Communication is not permitted while the battery mark is flickering.) • Check if USB driver has been installed in the PC. (See “3-3 Installation” (page40).)
<p>(5) Data save is disabled.</p>	<ul style="list-style-type: none"> • The data storage capacity has been filled up. Cancel the “FULL” status (number of data : 250) by operation from the main body. (See page21.) Or, delete the entire data in a batch from the PC (using software). (See page48.) • Data save is disabled if the built-in backup battery has expired. It is the time of replacement of the built-in battery. Please contact our nearest distributor.
<p>(6) Switch operation is disabled.</p>	<ul style="list-style-type: none"> • Turn OFF the power and then turn ON the power again. • Check the battery capacity, and replace batteries if the battery mark is flickering. • If the battery capacity drops to a level at which the battery mark begins to flicker during communication with a PC, the battery marks keeps flickering and switch operation is kept disabled, even if the communication status is cancelled by disconnecting the USB cable. Turn OFF the power and then turn ON the power again. • Switches on the main body are disabled during communication. • Switch operation is disabled, if connection of this detector to a PC is established. Disconnect the USB cable, if communication is not in progress.

10. Description of terms

The terms used in this operation manual are described in this section.

- **Notch filter**

Selection out of OFF, 50Hz and 60Hz can be made by the operation of the NF switch. The initial status is OFF.

Types of filters are briefly described below.

Besides those which do not allow passage of waves of a certain frequency and up (or below) such as high-pass filter and low-pass filter, there are band-pass filters (BPFs) that allow passage of waves of a certain frequency band only, band rejection filters (BRFs; not called band cut filters, as they do not remove the target frequency only) that do not allow passage of waves of a certain frequency level, notch filters (NFs) of particularly narrow frequency bandwidth among band rejection filters and com filters, which are composite bodies of notch filters.

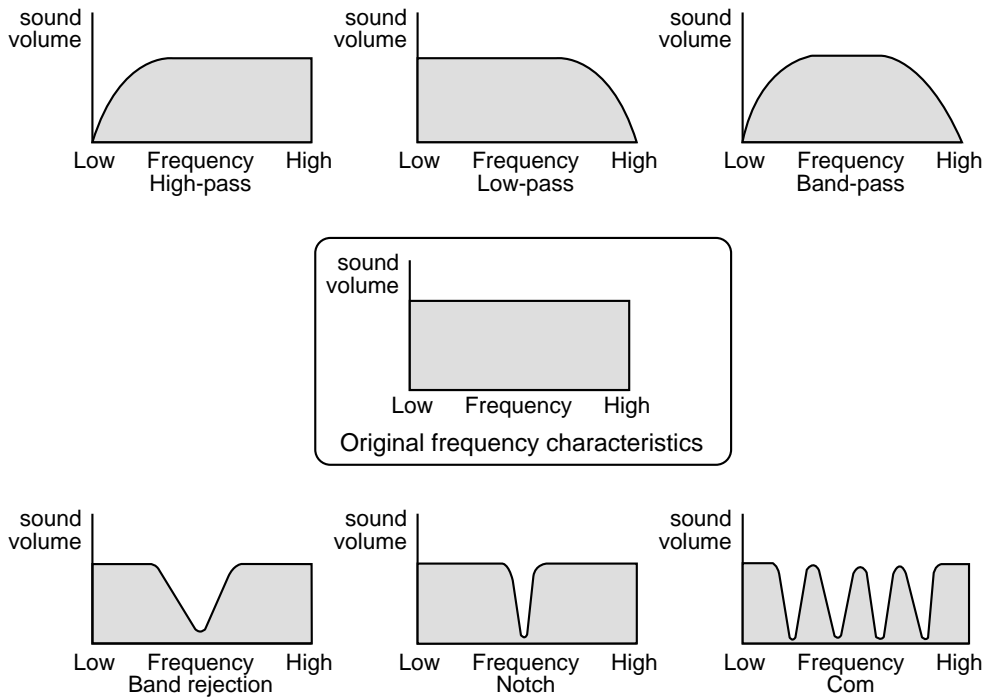

A notch filter cuts components of a certain frequency band only as shown above. As the notch filter combines such filters, it may be more appropriate to call it com filter. But it is indicated as notch filter for this detector. The notch filter is applied up to five stages in this detector in each of 50Hz and 60Hz.

The exclusive frequency levels in case of 50Hz are 50, 100, 150, 200 and 250Hz; and the exclusive frequency levels in case of 60Hz are 60, 120, 180, 240 and 300Hz.

If it appears that the pickup is picking higher harmonics of commercial frequency 50Hz or 60Hz, activate the notch filter function and carry out water leak detection work.

- **Minimum level value**

This value relatively expresses the minimum value of the vibration level picked up with the sensor during sound hearing. (000 to 999)

This value remains unchanged even if the SENS value is changed, if the input is constant.

However, if the SENS value was changed, once release the sound hearing switch and then press it again.

Point

Measurement of minimum level value can be performance at high accuracy, if SENS is set at 17 or higher.

- **Bar numerical value**

Numerical value of level bar display. (00 to 99)

11. Equipment specification

[Hardware]

11-1 Specification for main unit

- Total sensitivity : 900V / G or higher (400Hz)
- Power supply : Alkali C-size (LR14) battery × 4
: AA-size batteries may also be used.
(However, a conversion adaptor is required.)
- Working temperature range : -20°C to +55°C
- Minimum working voltage : 4.1V (However, it is different for continuous working.)
- Continuous working time : 24hours or longer (based on our conditions)
- Conforming standard : IP52 equivalent
- Display : Dot matrix LCD (128 × 64)
- External connection and terminals : Power switch × 1
Sensitivity select switch (SENS) × 1
Sensor input connector (with drip-proof cap) × 1
Headphone jack (with drip-proof cap) × 1
USB port (with drip-proof cap) × 1
Alternate ON / OFF switch × 1
- Filter : High-pass Thr, 100, 200, 400Hz
: Low-pass 400, 600, 800, 1200, 2200Hz
(Setup of BPF 400, that is 400Hz, is not permitted.)
: Notch filter 50Hz, 60Hz, OFF
- NR system : OFF
: LEVEL 1 : 0.2second
: LEVEL 2 : 1.0second
: LEVEL 3 : 3.0second
- Backup power supply : Built-in primary cell
- Backup period : 8 years or higher (20°C)
- Saved data : Minimum level value, data No., date / hour, flag information
- Number of save files : 250
- External interface : USB
- Dimensions and weight : 163(W) × 76.5(D) × 145(H) mm
: 780g (excluding batteries)

11-2 Specification for pick-up

- Type : Piezoelectric-type
- Conforming standard : IP67 equivalent (water depth 1m, 30minutes)
- External dimensions : $\phi 78 \times 50$ mm (excluding cable section)
- Weight : 580g
- Power supply voltage : 3.3V DC

11-3 Specification for headphones

- Method : Stereo, enclosed type
- Impedance : 8 Ω
- Headphone terminal diameter : $\phi 6.3$

11-4 Specification for USB connecting cable

- Standard : USB1.1
- Connector : A-B type
- Length : 1.5m

Software Volume

1. Introduction

[Software]

1-1 What is “WLDwin software”?

This software loads measured data saved in a water leak detector (LD-18) to a PC and executes data edit, graph display and data save.

1-2 Operating environment (recommended)

Software (OS) : Windows Vista, XP, 2000

Hardware : Hard disk having a free space of 100MB minimum
CD-ROM drive
USB port (1.1 or later)

Others : USB connecting cable

1-3 Before use

- A dedicated driver is required in the PC where this software was installed, for implementation of data communication with this detector connected to a PC. Install the driver after installation of this software.
- Use the provided USB connecting cable for communication with this detector.
- Turn ON the power for the detector and check the battery capacity before connecting this detector to the PC. Data communication is not permitted if the battery mark on the detector is flickering.

2. Installation and start-up of WLDwin software

[Software]

2-1 Installation

1. Set the WLDwin software CD-ROM in the CD-ROM drive.
The installer starts up automatically.

* Caution

If the installer fails to start-up automatically, execute “setup.exe” contained on the CD-ROM.

2. Installer start-up screen
Click the [Next] button.

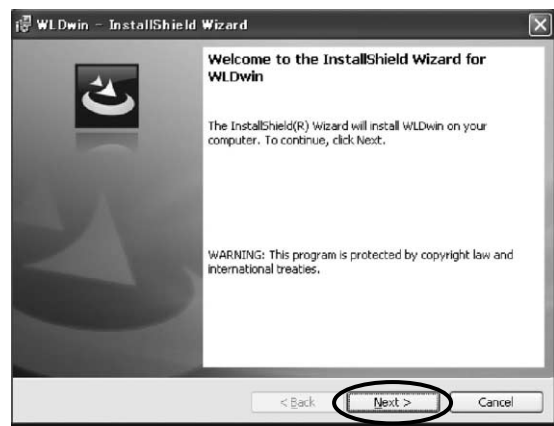

3. User information entry screen
Enter necessary user information, and then click the [Next] button.



4. Setup of installation destination folder.
Change the installation destination folder as required, and then click the [Next] button.

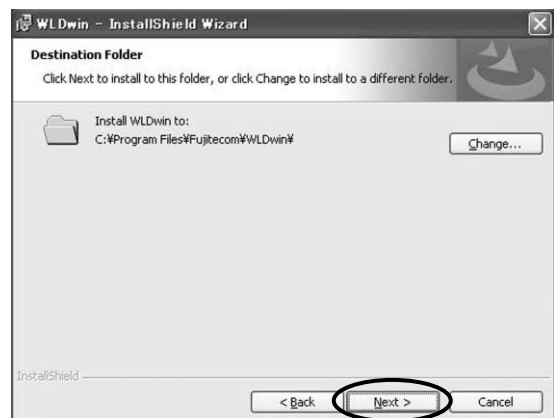

5. Installation preparation end screen.

Installation begins when the [Install] button is clicked.

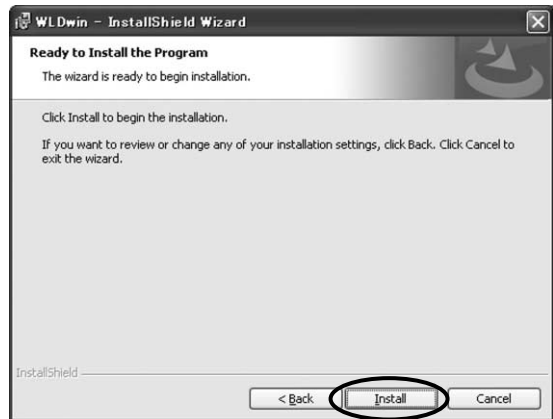

6. Installation execution screen.



7. Installation end screen.

Installation has been completed.

Terminate the installer by clicking the [End] button.



2-2 Start-up of WLDwin software

1. Start-up of application

The application starts up as a result of the following operation;

[Start] → [Program] → [FUJI TECOM] → [WLDwin]

Or by the use of the [WLDwin] shortcut on the desktop.

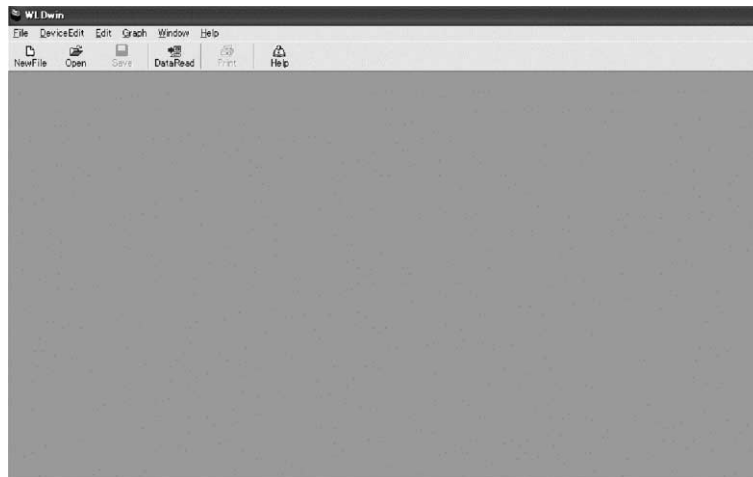

2. Confirmation of start-up : Open saved file

The “Open a file dialogue appears when [File] → [Open] operation is implemented.”

The graph screen appears when a data file is opened out of “WLD-Data” folder, which is the destination of installation.

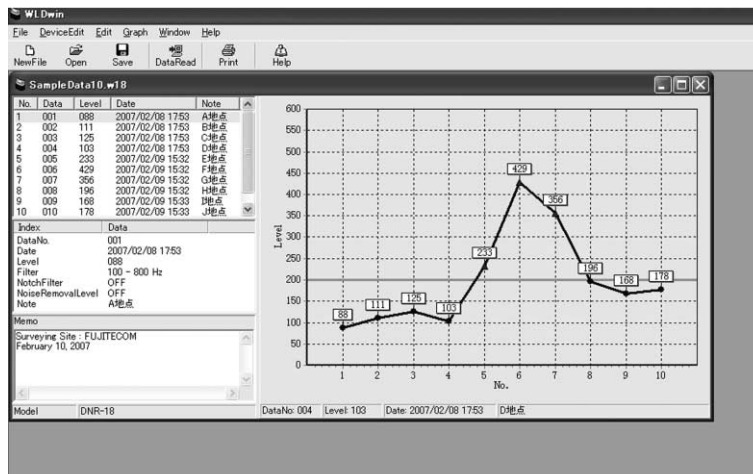

3. Driver installation

[Software]

3-1 Installation

The driver is automatically searched for and is installed when a detector (water leak detector LD-18) is connected a PC using a USB connecting cable.

It is necessary to install “CP210x USB Composite Device” and “CP210x USB to UART Bridge Controller” for the use of this function.

* Caution

- Check if the power for the detector is ON, before connecting it to a PC.
- The driver file is normally copied to ‘C:\Program Files\Fujitecom\DNRwin\SiLabs\MCU\CP210x\Win2K_XP’ at the time of installation of WLDwin software.
- Please never pull out the cable while installing data.

1. Installation of “CP210x USB Composite Device”

Turn ON the power for the detector and connect the detector to a PC using a USB connecting cable. A message appears in the right lower part of the screen.



2. Start-up of hardware search wizard

No connection to Windows Update is required. Check [No connection] and then click the [Next] button.



3. Automatic search for driver

The driver is searched for automatically and installation is executed. Check [Install automatically] and then click the [Next] button.



4. Execution of search and installation

“CP210x USB Composite Device” is installed automatically.



5. Completion of installation

Installation of “CP210x USB Composite Device” completes. Terminate the hardware search wizard by clicking the [Complete] button.



6. Installation of “CP210x USB to UART Bridge Controller”

A message appears in the right lower part of the screen again.



7. Start-up of hardware search wizard

The driver is searched for and installation if executed again. Check [Install automatically] and then click the [Next] button.



8. Execution of search and installation

“CP210x USB to UART Bridge Controller” is searched and installed for automatically.



9. Completion of installation

Installation of “CP210x USB to UART Bridge Controller” completes.

Terminate the hardware search wizard by clicking the [Complete] button.



10. Preparation for use of the UBS driver was completed.

A message stating ready for use appears in the right lower part of the screen.



3-2 Check of communication with detector

1. Start-up of WLDwin software

The WLDwin software starts up as a result of the following operation;

[Start] → [Program] → [FUJI TECOM] → [WLDwin]

Or by the use of the [WLDwin] shortcut on the desktop.

2. Turn ON the power for the detector (water leak detector LD-18), and connect the detector with a PC using a USB connecting cable.

3. Check of communication: Transfer of data from detector

Execute [expenses edit] → [Data read].

The communication status indicator lights up, and the saved data display dialogue opens.

[Data narrow-down] : Select either data No. or recorded date / hour, and execute data narrow-down in the specified range.

[Graph display] : The data selected in accordance with the dialogue are displayed in a graph format.

[Re-read] : Data read from the detector is executed again.

[Close] : The saved data display dialogue is closed. (End of data read)

Point

See “4-2 Data read” (page44).

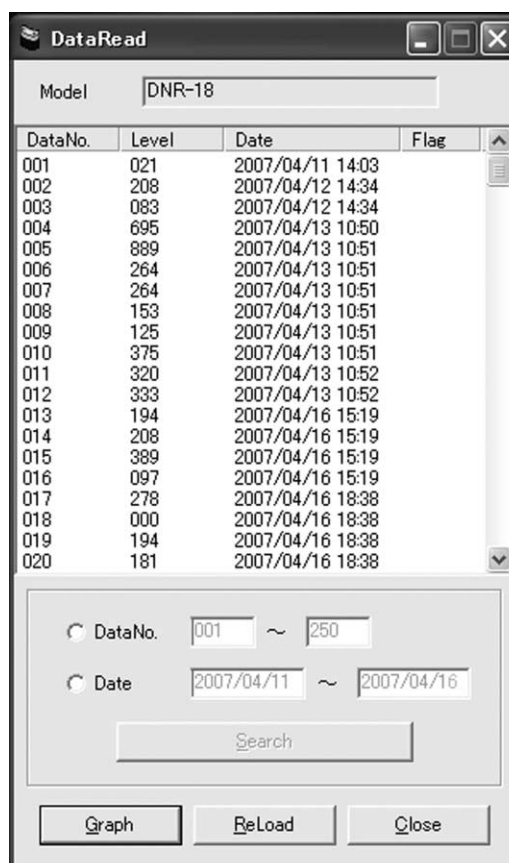

3-3 Installation: If the hardware search wizard fails to start automatically

If the hardware search wizard fails to start automatically when the detector (water leak detector LD-18 in the state where the power is ON) is connected to a PC, make connection once again or manually install the driver.

1. Connection of detector with PC

Turn ON the power for the detector and connect the detector to a PC using a USB connecting cable.

2. Start-up of device manager

Open the device manager in the following sequence:

[Start] → [Control panel] → ([Performance and maintenance]) → [System] → [Hardware] → [Device manager]

3. Have the popup menu displayed by performing right-click on “CP2101 USB to UART Bridge Controller”.

The hardware update wizard starts when [Hardware update] is selected out of the displayed popup menu.

4. Automatic search for driver

Select [Install automatically] and then click the [Next] button.

In case of [Install from a specific place], select the following folder and execute search in a usual case.

C:\Program Files\Fujitecom\WLDwin\SiLabs\MCU\CP210x\Win2K_XP

Point

The subsequent processing is identical to that of “3-1 Installation” (page36) and subsequent.



4. Description of functions of WLDwin software

[Software]

4-1 Main screen (that appears at the time of start-up)

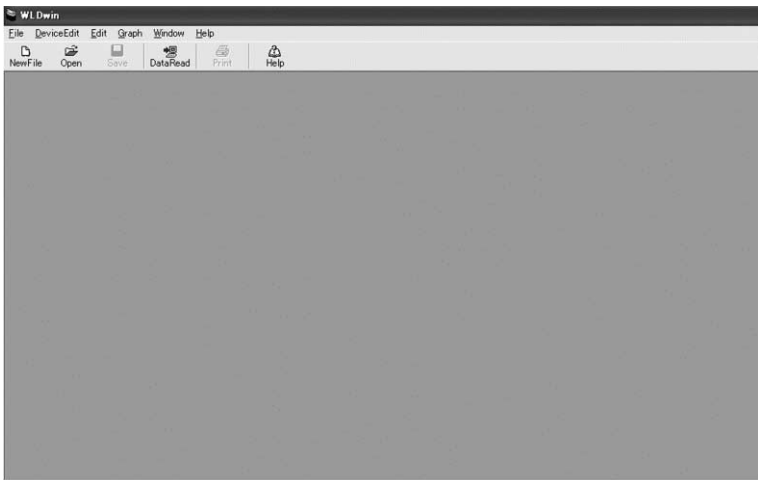

(1) Main menu

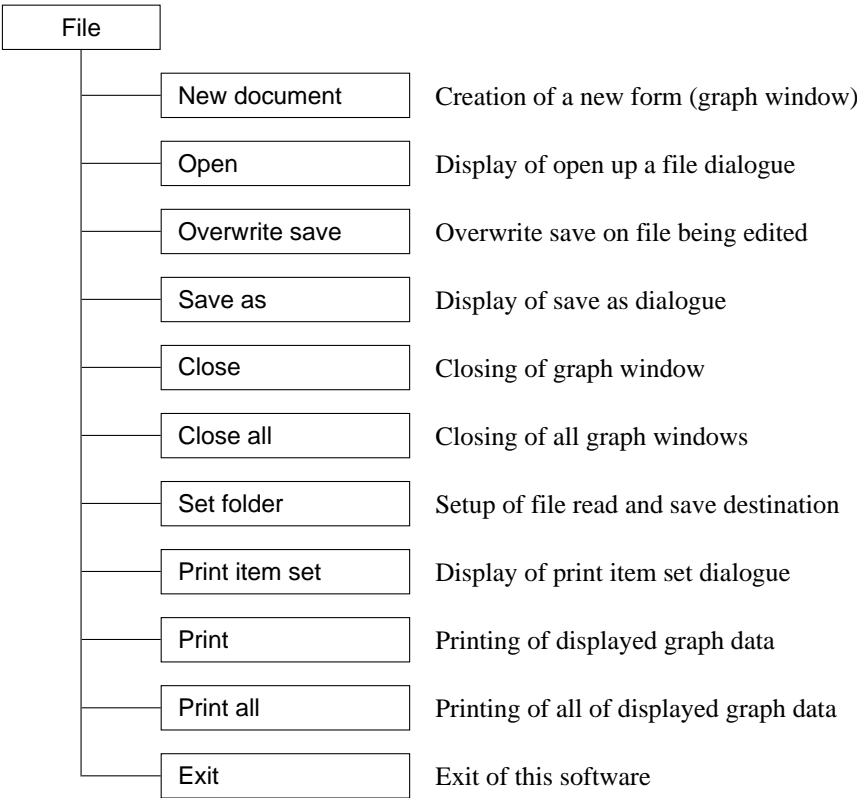

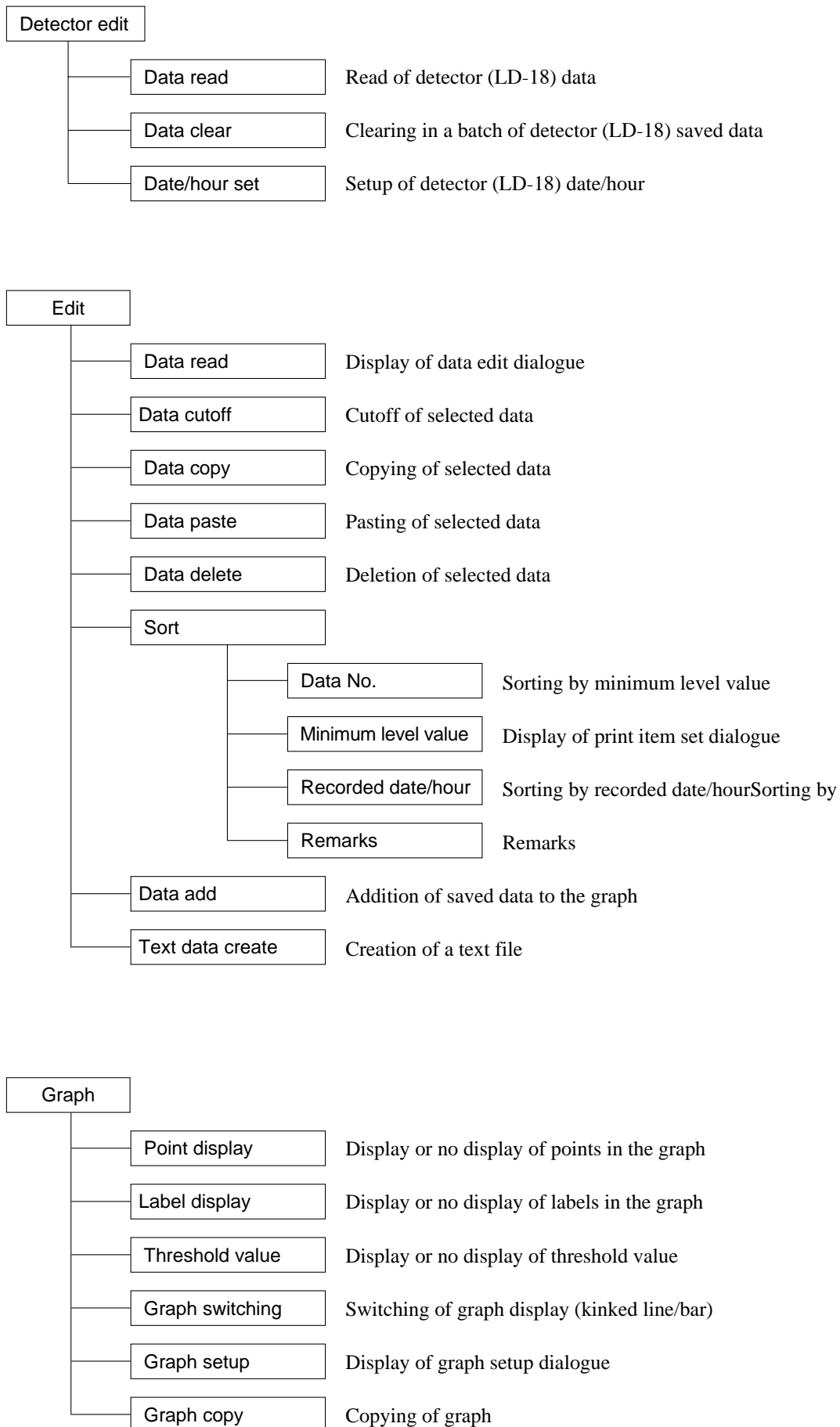

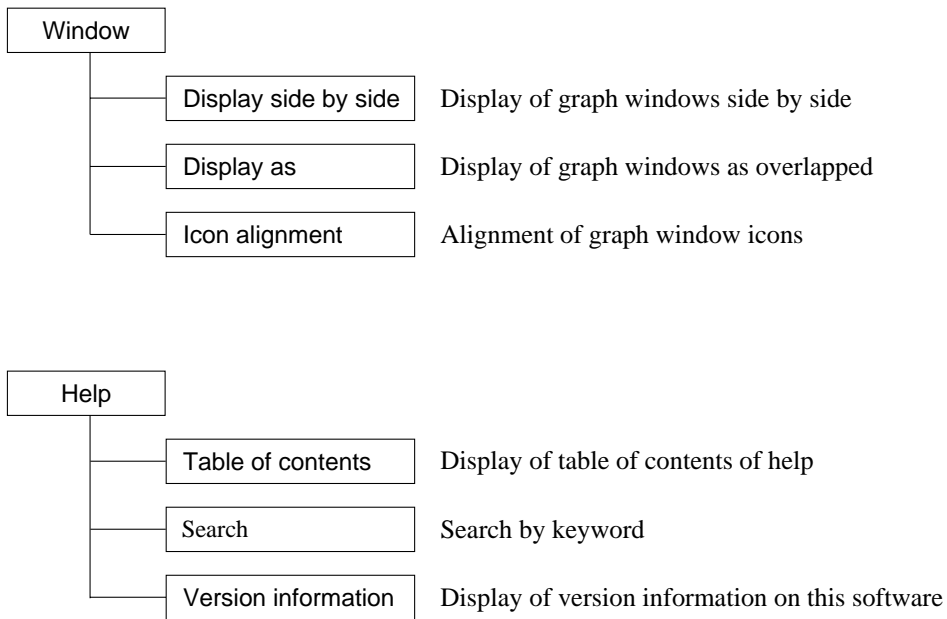

(2) Tool buttons

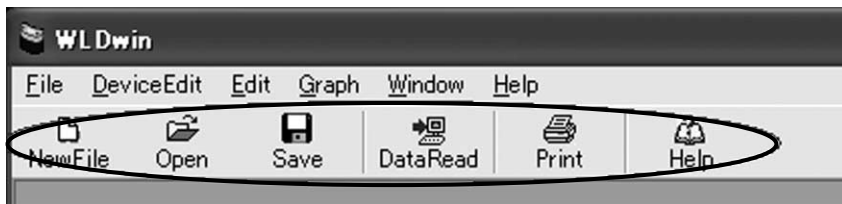

- Main menu shortcut buttons

It is possible to execute creation of new document, read of saved file, file save, detector data read, print and help.

4-2 Data read

- Saved data is read from the detector (water leak detector LD-18) when “Data read” is selected out of the main menu.
- Transfer in a batch of detector saved data is executed after confirmation of connection of the detector. Data is displayed in a list format in the saved data dialogue upon normal termination of transfer.
- Data No., minimum level value, recorded date / hour, filer (HPF, LPF, NF), noise reduction level and flag data are acquired from the detector.

(1) Confirmation of connection of the detector

- USB connection of the detector with a PC is confirmed.
- The connection check dialogue appears if connection cannot be confirmed or if the power for the detector is not ON.



(2) Saved data dialogue

- Data No., minimum level value, recorded date / hour and flag are displayed in a list format in the dialogue.
- The data displayed in a list format can be narrowed down by data No. and recorded date/hour.

[Graph display] : A graph window is created using data selected out of the list shown in the dialogue. Up to 250 data can be displayed in a graph format.

*Multiple data may be selected by making selection while the Ctrl key and Shift key are kept pressed or by dragging the data No. display area.

[Re-read] : Data read from the detector starts again.

[Close] : End of saved data dialogue.

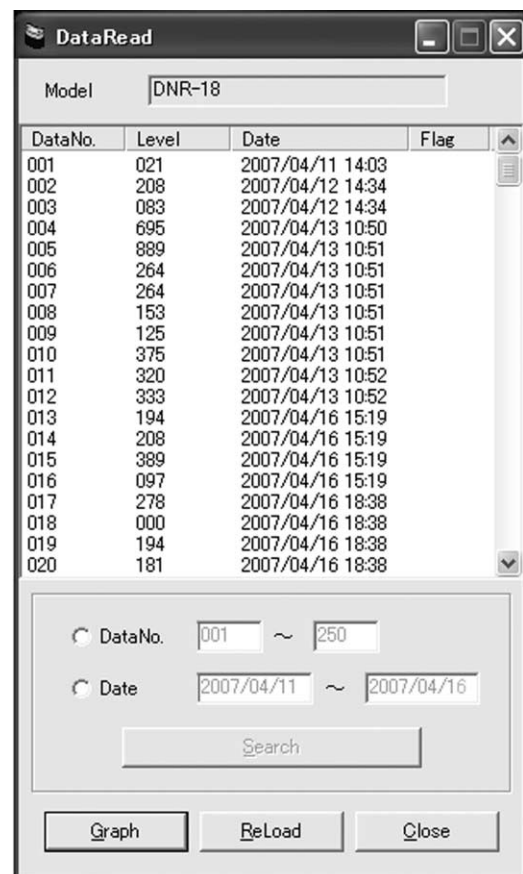

4-3 Data read

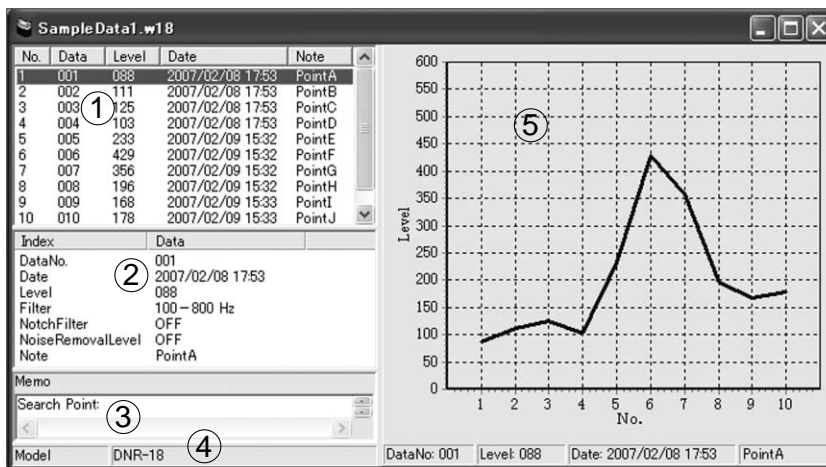

① Data display : The entire data

- The entire data in a graph format are displayed in a list format.
- Data edit : The data edit dialogue appears when “Data edit” is selected out of the main menu or when the list is double-clicked.

(Shown below on the right-hand side.)

Editing of data No., date / hour and remarks and deletion of selected data can be implemented.

- Data move : Data move can be implemented by selecting “Data cutoff”, “Data copy” or “Data paste” out of the main menu or by drag & drop in the list.

Point

Selection of multiple data and data move between windows are also permitted.

- Data delete : The selected data is deleted by “Data delete” in the main menu or by clicking the Delete key

Point

Deletion of multiple data is also permitted.

- Sort function : Sorting by data No., minimum level value, date / hour and remarks is permitted by “Sort” of the main menu or by clicking an item column of the list.

② Display of data detail

- Details of one selected data are displayed.
- The data edit dialogue appears when double-click is made.

③ Entry of comment

- Directly entry of a sentence is permitted when the comment column is selected.

④ Display of detector model

- The name of the detector used for measurement of data displayed in the graph is displayed.

⑤ Graph area

- A graph is displayed by a kinked line graph or a bar graph.
- Display or no display of points can be selected by “Display of points” in the main menu.

Point

- A point is marked by ▲ in case the numerical value is higher than the threshold value.
- A point is marked by ● in case the numerical value is equivalent to or lower than the threshold value.

- Display or no display of labels can be selected by “Display of labels” in the main menu.

- Display or no display of the threshold value can be selected by “Display of threshold value” in the main menu.

⑤

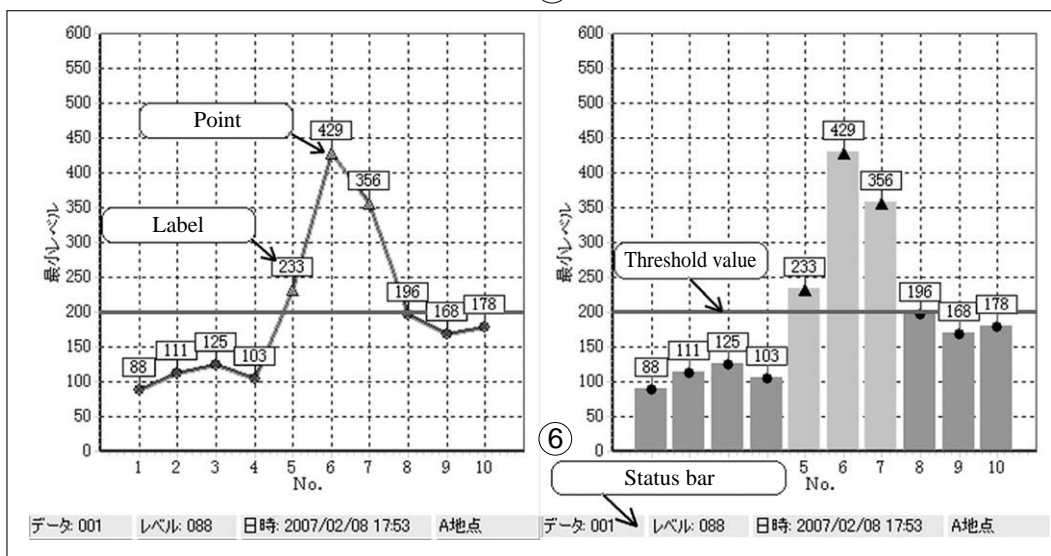

(Kinked line graph)

(Bar graph)

⑥ Status bar

- The value of the point where the cursor is located is displayed in the status bar underneath the graph.

⑦ Graph setup

- The graph setup dialogue appears when “Graph setup” is selected out of the main menu or when double-click is performed on the graph.

Changes to graph display setup, threshold value setup and Y-axis setup is permitted.

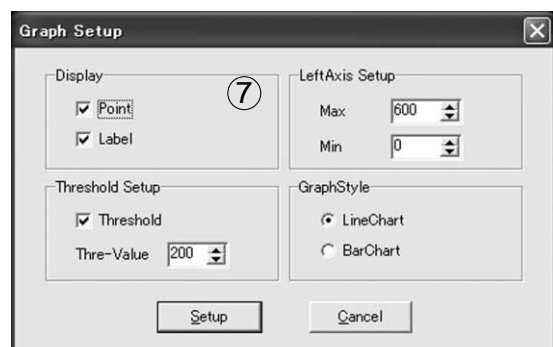

4-4 Data save

- Save edited data (extension .w18) in the PC.

4-5 Text data create

- Save edited data in the PC in a text format (extension .txt).
- Saved data can be edited with another application.

* Caution

The created text file cannot be re-edited with this WLDwin software.

4-6 Graph copy

- The graph being displayed is copied to the clip board by image data, when “Graph copy” of the main menu is executed.
- The copied graph may be used with another application.

4-7 New document

- Create a new graph window.
- It is possible to paste data to the window by “Data add”, “Data move” and others and to then edit it.

4-8 Folder setup

- Set the folder that opens first at the occasion of “Open up a file” or “Save as”.
- Also at the time of “Save in a batch” during termination processing, files are automatically saved in the folder set here.

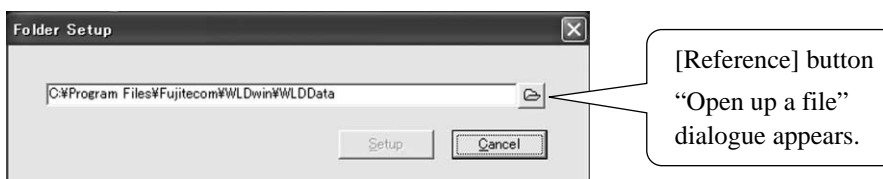

4-9 Print

(1) Print item setup

- Have the print item setup dialogue by “Print item setup” in the main menu.
- Printing is permitted with graph, comment, list item and / or required data item selected.

(2) Print

- The data selected by the print item setup dialogue is printed when “Print” is selected out of the main menu or when tool button “Print” is clicked.

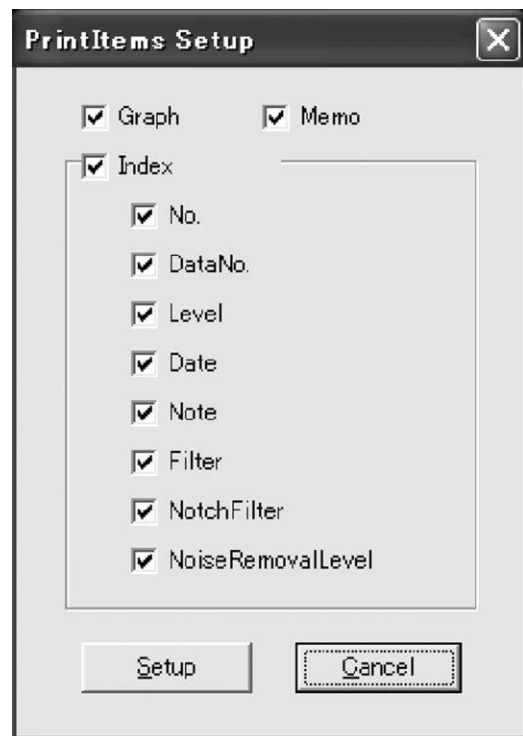

4-10 Clearing of saved data in detector

- The saved data in the connected detector is cleared in a batch when “Detector data clear” is selected out of the main menu.
- The saved data is cleared in practice after a clearing confirmation message was displayed.

* Caution

Data restoration is not permitted after the data was cleared.

4-11 Setup of detector date / hour

- Set the date / hour of the connected detector at the date / hour of the PC by “Setup of detector date / hour” of the main menu.
- The date / hour is set in practice after a date / hour setup confirmation message was displayed.

4-12 Termination processing

- At the occasion of “Close”, “Close all” or “Exit” of the main menu, a save confirmation message is displayed if new data has not been saved or if the displayed data has been changed.

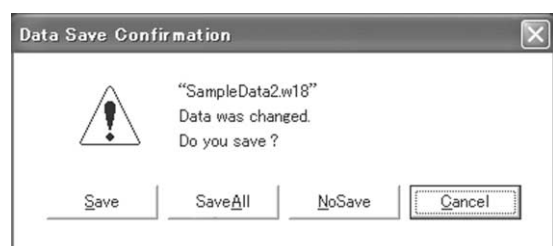

[Save] : The save as dialogue appears.

[Save in a batch] : The changed data only is automatically saved in a batch in the folder set in “4-8 Folder setup”.

*** Caution**

- Saved as a new file instead of overwrite save.
- File name = “File name + Recorded date / hour + Saved date/hour + Consecutive number + .w18”

[Do not save] : The window closes without save processing.

[Cancel] : The termination processing is cancelled.

4-13 Help

- A simplified operation manual of this software is displayed.

5. WLDwin error message

[Software]

Message	"Connect the detector!"
Meaning	Connected detector cannot be confirmed at the time of execution of detector edit menu.
Cause and remedy	<ul style="list-style-type: none"> ● Check connection between PC and detector, and check if the power for the detector is ON. * See Software Volume "3-2 Check of communication with detector" (page39). ● Check if the dedicated driver has been correctly installed. * See Software Volume "3 Installation of driver" (page36).

Message	"No response from detector. Interrupted!"
Meaning	Communication was interrupted due to any reason during communication with the detector.
Cause and remedy	<ul style="list-style-type: none"> ● Check connection between PC and detector, and check if the power for the detector is ON. * See Software Volume "3-2 Check of communication with detector" (page39). ● Check the battery capacity of the detector. * See Hardware Volume "3-2 Check of battery capacity" (page12).

Message	"Data read ended in failure!"
Meaning	Failure in data read
Cause and remedy	<ul style="list-style-type: none"> ● Check connection between PC and detector, turn ON the power for the detector again, and execute data read.

Message	"Data clear ended in failure!"
Meaning	Failure in data read
Cause and remedy	<ul style="list-style-type: none"> ● Check connection between PC and detector, turn ON the power for the detector again, and execute data clear.

Message	"Setup ended in failure!"
Meaning	Failure in setup of detector date / hour
Cause and remedy	<ul style="list-style-type: none"> ● Check connection between PC and detector, turn ON the power for the detector again, and execute date / hour setup.

Message	"Data is incorrect! There is a possibility where displayed data is erroneous."
Meaning	Failed in read of saved file.
Cause and remedy	<ul style="list-style-type: none"> ● There is a possibility where the saved file was broken. If data in the saved file was broken, re-edit with this software is not permitted.

Message	"Maximum number of data was exceeded! The number of data is 250 at maximum."
Meaning	Number of graph display data is excessive at the time of data add or data move.
Cause and remedy	<ul style="list-style-type: none"> ● Graph display of up to 250 data is permitted. If the maximum number of data was exceeded at the time of data add or data move, there is data that is not displayed. Be cautious.

Message	"Y-axis set value is incorrect!"
Meaning	Error in setup of Y-axis (vertical axis) during graph setup
Cause and remedy	<ul style="list-style-type: none">● Check the maximum value and minimum value of Y-axis (vertical axis) * See Software Volume "4-3 ⑦ Graph setup" (page46).

Message	"Folder not found"
Meaning	The specified folder was not found at the time of save destination folder setup.
Cause and remedy	<ul style="list-style-type: none">● Confirm the save destination folder and set it again. * See Software Volume "4-8 Folder setup" (page47).

Parts list and illustrations

(1) Main unit

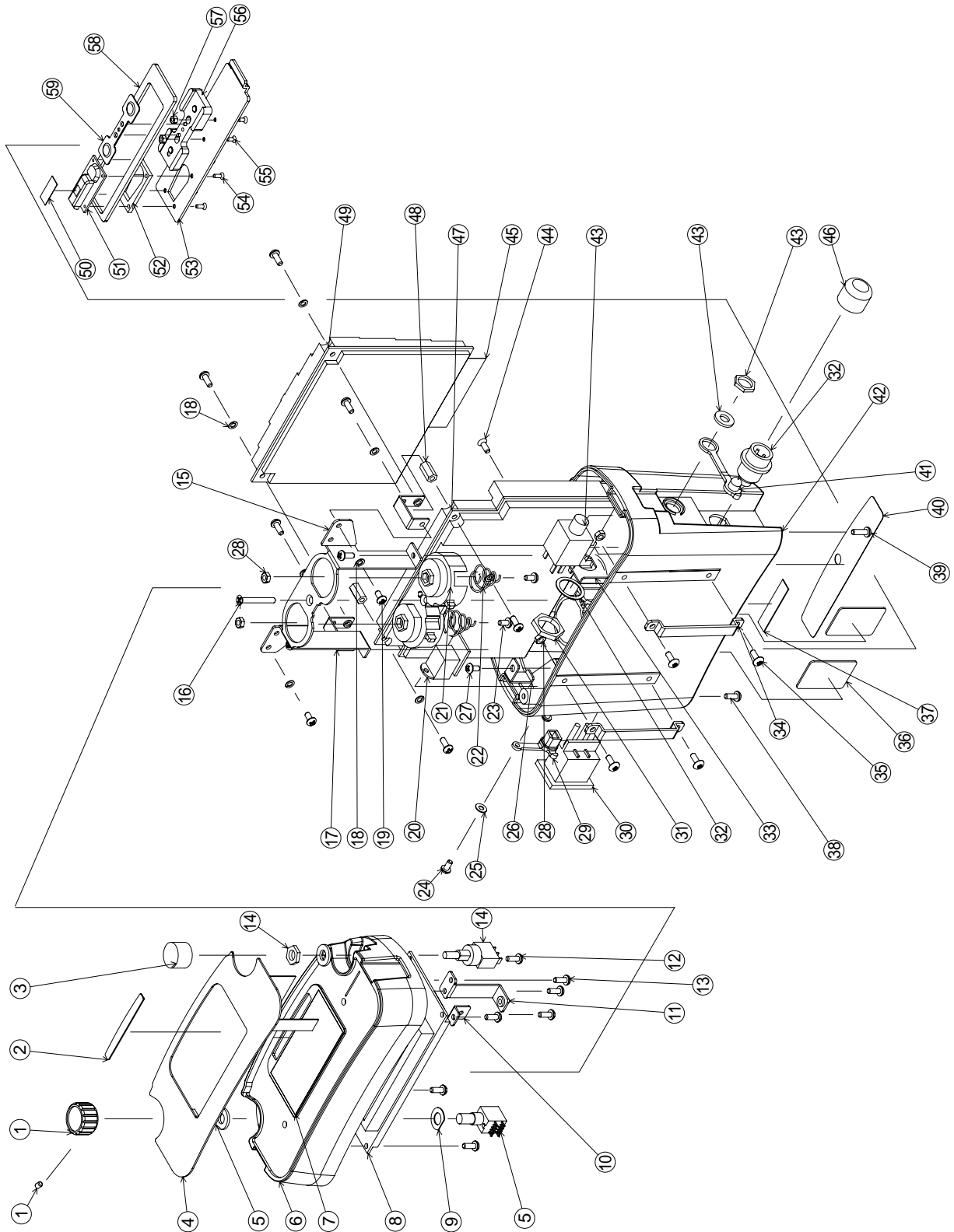

< >=Order Code

- ① Sensitivity knob <234121>
- ② Company name label <234117>
- ③ Color button (black) <incl. No.14>
- ④ Membrane switch <234119>
- ⑤ Sensitivity switch assembly <234138>
- ⑥ Housing case (Upper side) <234134>
- ⑦ with LCD panel <234134>
- ⑧ LCD harness assembly with chassis <234142>
- ⑨ Rubber washer for sensitivity switch <228406>
- ⑩ Case bracket (A) <228313>
- ⑪ Case bracket (B) <228314>
- ⑫ Tapping screw (3x8)
- ⑬ Tapping screw (3x16)
- ⑭ Short-circuit switch assembly <234140>
- ⑮ Battery holder <228303>
- ⑯ Flat tapping screw (3x25)
- ⑰ PCB bracket <234116>
- ⑱ Spring washer
- ⑲ Small screw (M3x6)
- ⑳ PCB assembly for USB <234128>
and the connecting harness <234141>
- ㉑ Battery terminal base <228205>
- ㉒ Battery spring <046128>
- ㉓ Tapping screw (3x10)
- ㉔ Tapping screw (3x8)
- ㉕ Metal washer
- ㉖ Stiffening plate for snap latch <228315>
- ㉗ Tapping screw (3x6)
- ㉘ Hexagon nut (M3)
- ㉙ Waterproof cover for USB connector <234120>
- ㉚ Power harness assembly <234139>
- ㉛ Hexagon nut (M14) <228402>
- ㉜ Harness assembly of sensor input <234135>
- ㉝ Holding plate for P.U. <228320>
- ㉞ Waist belt fittings <007113>
- ㉟ Binding small screw (M3x10)
- ㊱ Battery cushion <234125>
- ㊲ Serial numbers label
- ㊳ Tapping screw (3x16)
- ㊴ Small screw (M3x10)
- ㊵ Serial No. panel label (silk print) <234118>
- ㊶ Waterproof cover for headphone <228407>
- ㊷ Housing case (Lower side) <234133>
- ㊸ Headphone harness assembly <234136>
- ㊹ Small screw (M3x5)
- ㊺ Model name plate <234115>
- ㊻ Headphone connector cove <234009>
- ㊼ Digital PCB <234126>
- ㊽ Spacer <234132>
- ㊾ Analog PCB <234127>
- ㊿ Rubber cushion for battery latch <234131>
- ① Snap latch for battery <007114>
- ② Snap latch base <228309>
- ③ Battery cover <228308>
- ④ Small screw (M2x6)
- ⑤ Small screw (M2x4)
- ⑥ Battery terminal base <234113>
- ⑦ Hexagon nut (M2)
- ⑧ Battery cover packing <228405>
- ⑨ Battery terminal <228311>

(2) Hand-switch set with pick-up sensor

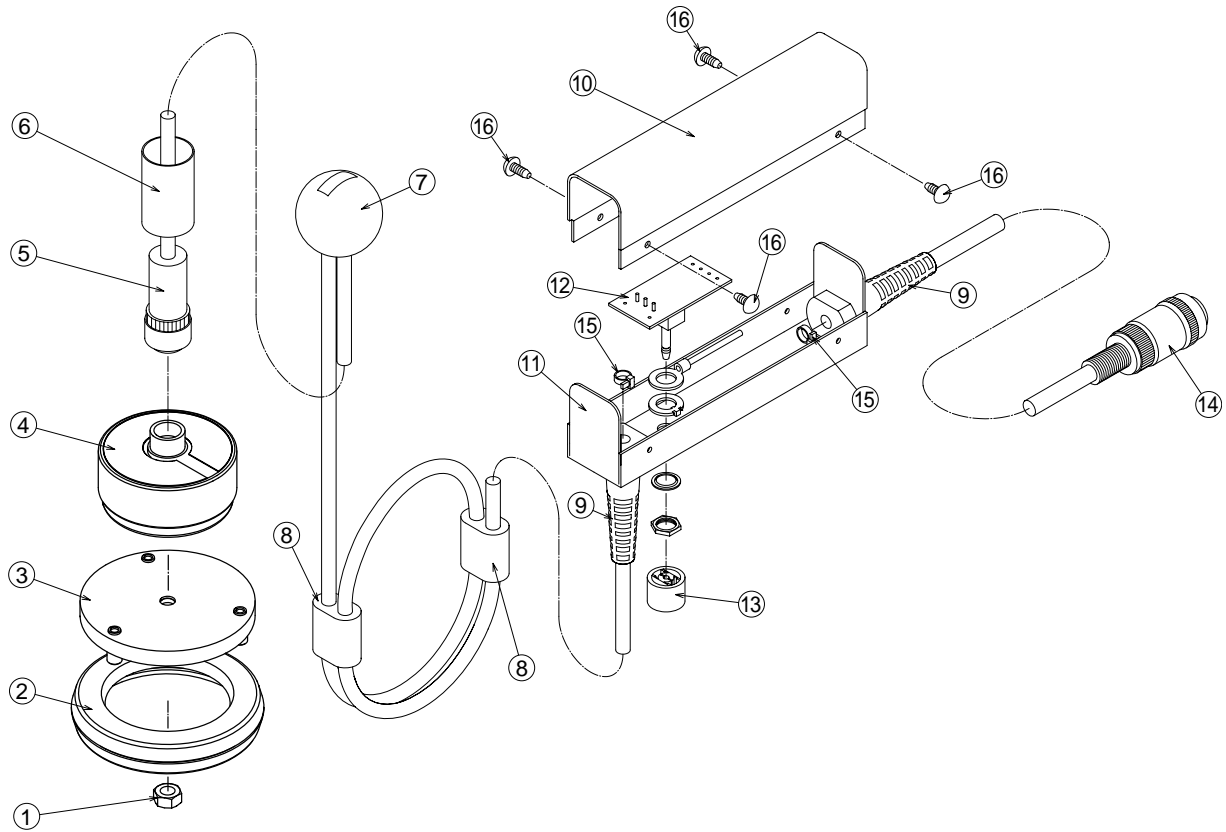

< >=Order Code

- | | |
|--|---|
| ① Hexagon lock nut (M6) | ⑨ Rubber bushing <007133> |
| ② Disc plate cover <007138> | ⑩⑪ Hand-set case x 2 (top & botom) <007128> |
| ③ Disc plate <234306> | ⑫ Hand-switch assembly with PCB <234204> |
| ④ P.U. Element assembly <234309> | ⑬ and color button (black) <234204> |
| ⑤ Water-proof connector (A) <080170> | ⑭ Water-proof connector (B) <234205> <234206> |
| ⑥ Heat contraction tube <234207> | ⑮ Tight stopper |
| ⑦ Noise alleviation rubber-ball <234203> | ⑯ Tapping screw (M3x8) |
| ⑧ Cord length adjuster <234202> | |

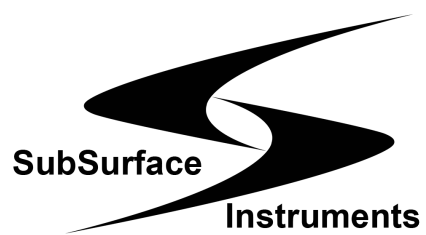

SubSurface Instruments, Inc.

1230 Flightway Dr.

De Pere, WI

54115

United States

Tel.: (920) 347-1788 • Fax: (920) 347-1791

email: info@ssilocators.com

www.ssilocators.com